

SISTEMI LINEARI

LINEAR SYSTEMS

PLAFONE

- **MINI CLIP 120**
- **JEY CLIP 121**
- **ZETA CLIP 122**
- **OMEGA CLIP 123**
- **RHO CLIP 124**
- **YPSILON CLIP 125**
- **OMEGA 126**
- **ALFA1 127**
- **ALFA2 128**
- **ZETA 129**
- **GAMMA 130**
- **VEGA 131**
- **BETA 132**
- **VIRGO IR 133**
- **VIRGO PIR 134**
- **DELTA 135**
- **KAPPA 136**

MINI CLIP

M1.

Lampada in alluminio anodizzato, completa di diffusore satinato a pressione, supporti laterali e LED ad alta luminosità con elevato rapporto Lumen/Watt. Particolarmente adatta per illuminazione d'accento e di servizio. Indicata per arredi, residenziale, retail ed illuminotecnica in genere. Installabile a plafone su qualsiasi superficie.

Montaggio a pressione con clip in policarbonato trasparente.

Linea minimal dalle ridotte dimensioni.

- Diffusione "full light".
- Ampia gamma di soluzioni illuminanti e dimensioni personalizzabili.
- Alimentazione: 12/24 Vdc.
- Clip comprese della confezione.

COLLEGARE IN PARALLELO

Anodized aluminium lamp complete with satin diffuser, lateral supports and high brightness LED with very good relation between Lumen/Watt. It is suitable as accent and service lightin, on furnishings, for residential loctions, retail and for lighting technique.

I can be ceiling recessed on any type of surface. Mounting with trasparent polycarbonate clips. Modern and essential design.

- Diffuser with snap fitting and with full-light effect.
- Wide range of lighting solution, customizing dimensions and control of the light on lamp border.
- Power supply: 12/24 Vdc.
- Clip included in the box.

CONNECT IN PARALLEL

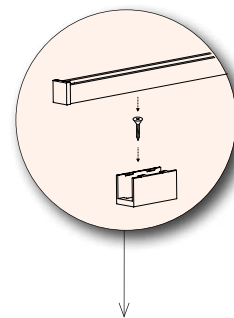

DIMENSIONI / DIMENSIONS

ACCESSORI / ACCESSORIES

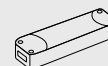

Alimentatori pag. 258-260
Drivers page 258-260

CODICI BASE / BASE CODES

FINITURE / FINISHINGS

SUPPORTI LATERALI / LATERAL SUPPORT

M1.

- 1 Bianco RAL 9003
White RAL 9003
- 2 Nero opaco RAL 9005
Matt Black RAL 9005
- 7 Argento anodizzato
Anodized silver

- 1 Bianco
White
- 2 Nero opaco
Matt Black
- 7 Alluminio satinato
Satin aluminum

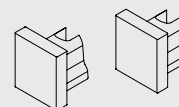

DIMENSIONI / DIMENSION

COLORE LED / LED COLOUR

POTENZA / POWER

- G 900mm
- H 1000mm
- I 1200mm
- L 1500mm
- M 1800mm
- N 2000mm
- O 2300mm
- P 2500mm
- Q 2800mm
- R 3000mm

- BN 4000°K
- BC 3000°K
- CC 2700°K

- I 9,6W/m 800lm/m
- N+ 7,5W/m 600lm/m
- O+ 9,6W/m 800lm/m

* Altre misure disponibili su richiesta
* More dimensions available

Esempio di codifica: Prodotto MINI CLIP + Finitura bianco + Supporti laterali bianco + Dimensione 900mm + Colore led 3000°K + Potenza 9,6W/m = Codice: M1.11GBNI
Example of codification: Product MINI CLIP + Finishing white+ Lateral support white + Dimension 900mm + Led color 3000°K + Power 9,6W/m = Code: M1.11GBNI

JEY CLIP

J1.

Lampada in alluminio anodizzato, completa di diffusore satinato, supporti laterali e LED ad alta luminosità con elevato rapporto Lumen/Watt. Particolarmente adatta per illuminazione d'accento e di servizio. Indicata per arredi, residenziale, retail ed illuminotecnica in genere. Installabile a plafone su qualsiasi superficie. Montaggio a pressione con clip in policarbonato trasparente. Linea minimal dalle ridotte dimensioni.

- Diffusione "full light".
- Ampia gamma di soluzioni illuminanti e dimensioni personalizzabili.
- Alimentazione: 12/24Vdc.

COLLEGARE IN PARALLELO

Anodized aluminium lamp complete with satin diffuser, lateral supports and high brightness LED with very good relation between Lumen/Watt. It is suitable as accent and service lightin, on furnishings, for residential loctions, retail and for lighting technique.

I can be ceiling recessed on any type of surface. Mounting with trasparent polycarbonate clips. Modern and essential design.

- Diffuser with snap fitting and with full-light effect.
- Wide range of lighting solution, customizing dimensions and control of the light on lamp boder.
- Power supply: 12/24Vdc.

CONNECT IN PARALLEL

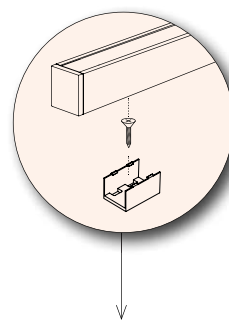

DIMENSIONI / DIMENSIONS



ACCESSORI / ACCESSORIES

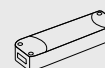

Alimentatori pag. 258-260
Drivers page 258-260

CODICI BASE / BASE CODES

J1.

FINITURE / FINISHINGS

- 1 Bianco RAL 9003
White RAL 9003
- 2 Nero opaco RAL 9005
Matt Black RAL 9005
- 7 Argento anodizzato
Anodized silver

SUPPORTI LATERALI / LATERAL SUPPORT

- 1 Bianco
White
- 2 Nero opaco
Matt Black
- 7 Alluminio satinato
Satin aluminum
- 1T Bianco con touch
White with touch
- 2T Nero opaco
Matt Black
- 7T Alluminio satinato con touch
Satin aluminum with touch

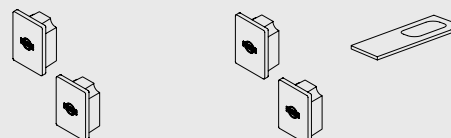

DIMENSIONI / DIMENSION

- G 900mm
- H 1000mm
- I 1200mm
- L 1500mm
- M 1800mm
- N 2000mm
- O 2300mm
- P 2500mm
- Q 2800mm
- R 3000mm

* Altre misure disponibili su richiesta
* More dimensions available

COLORE LED / LED COLOUR

- BN 4000°K
- BC 3000°K
- CC 2700°K
- * Le Strip colorate,
Bianco dinamico, RGB
sono disponibili su richiesta.
- * Colored, Tunable white,
RGB strip LED available up
on request.

POTENZA / POWER

- B 9,6W/m 800lm/m
- E 17W/m 2000lm/m
- F 21W/m 3500lm/m
- G 25W/m 2500lm/m
- K+ 22W/m 2500lm/m
- L+ 28W/m 3500lm/m
- P+ 14W/m 1400lm/m

Esempio di codifica: Prodotto Jey Clip + Finitura bianco + Supporti laterali bianco + Dimensione 900mm + Colore led 3000°K + Potenza 9,6W/m = Codice: J1.11GBNB
Example of codification: Product Jey Clip + Finishing white+ Lateral support white + Dimension 900mm + Led color 3000°K + Power 9,6W/m = Code: J1.11GBNB

ZETA CLIP

Z2.

Estruso in alluminio anodizzato dalle dimensioni particolarmente ridotte, disegnato e prodotto per essere installato su superfici anche di spessore minimo. Estrema facilità di montaggio garantita dal diffusore satinato ad inserimento a pressione, dai supporti laterali a pressione dalle clip in policarbonato. Ideale per ospitare e dissipare correttamente strip LED, particolarmente indicato per illuminare ed impreziosire pensili da cucine e bagni, sottopensili, mobili, armadi, mensole e vetrine.

- Alimentatore: 12/24 Vdc
- Clip comprese nella confezione

COLLEGARE IN PARALLELO

Anodized aluminium extruded with very reduced dimensions, designed and produced in order to be lay-in also on surfaces with a minimum thickness.

Extremely easy assembly thanks to the snap fitting satin diffuser, to the pressure lateral supports and by polycarbonate clips.

Perfect solution for hold and correctly dissipate LED strip.

It is suitable for lighting and to embellish kitchens and bathrooms shelves, under-wall unit, furnitures, wardrobes, shelves and showcases.

- Power supply: 12/24 Vdc
- Clip included in the box.

CONNECT IN PARALLEL

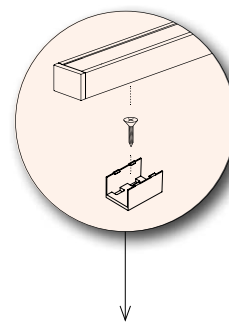

DIMENSIONI / DIMENSIONS



ACCESSORI / ACCESSORIES

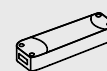

Alimentatori pag. 258-260
Drivers page 258-260

CODICI BASE / BASE CODES

Z2.

FINITURE / FINISHINGS

- 1 Bianco RAL 9003
White RAL 9003
- 2 Nero opaco RAL 9005
Matt Black RAL 9005
- 7 Argento anodizzato
Anodized silver

SUPPORTI LATERALI / LATERAL SUPPORT

- 1 Bianco
White
- 2 Nero opaco
Matt Black
- 7 Alluminio satinato
Satin aluminum
- 1T Bianco con touch
White with touch
- 2T Nero opaco
Matt Black
- 7T Allum. satinato con touch
Satin aluminum with touch
- 1S Bianco con sensore
White with sensor
- 2S Nero opaco
Matt Black
- 7S Allum. satinato con sensore
Satin alu. with with sensor

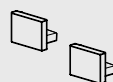

DIMENSIONI / DIMENSION

- G** 900mm
- H** 1000mm
- I** 1200mm
- L** 1500mm
- M** 1800mm
- N** 2000mm
- O** 2300mm
- P** 2500mm
- Q** 2800mm
- R** 3000mm

* Altre misure disponibili su richiesta
* More dimensions available

COLORE LED / LED COLOUR

- BN** 4000°K
 - BC** 3000°K
 - CC** 2700°K
- * Le Strip colorate, Bianco dinamico, RGB e RGBW sono disponibili su richiesta.
* Colored, Tunable white, RGB and RGBW strip LED available upon request.

POTENZA / POWER

- A** 4,8W/m 400lm/m
- B** 9,6W/m 800lm/m
- E** 17W/m 2000lm/m
- F** 21W/m 2500lm/m
- G** 25W/m 3500lm/m
- J+** 15W/m 1800lm/m
- K+** 22W/m 2500lm/m
- L+** 28W/m 3500lm/m
- P+** 14W/m 1400lm/m

Esempio di codifica: Prodotto ZETA CLIP + Finitura bianco + Supporti laterali bianco + Dimensione 900mm + Colore led 3000°K + Potenza 9,6W/m = Codice: **Z2.11GBNB**
Example of codification: Product ZETA CLIP + Finishing white+ Lateral support white + Dimension 900mm + Led color 3000°K + Power 9,6W/m = Code: **Z2.11GBNB**

OMEGA CLIP

01.

Profilo in alluminio da appoggio con fissaggio tramite CLIP.
Diffusione omogenea della luce LED grazie allo schermo in PMMA a infilare satinato fissato su asole interne. Possibilità di controllo della luce anche a bordo profilo, disponibilità di svariate misure anche personalizzabili e di molteplici tipologie di LED ad ALTA LUMINOSITÀ. Prodotto particolarmente indicato come illuminazione d'accento in cucine, armadi, mensole e quant'altro; adatto all'installazione su qualsiasi materiale o superficie.

- Alimentazione: 12/24 Vdc
- Clip di fissaggio comprese nella confezione

COLLEGARE IN PARALLELO

Lay-in aluminium profile with CLIP fixing. Thanks to a PMMA satin screen there will be a uniform diffusion of the light. Possibility to control light also on board profile. Different dimensions available, possibility to customize them and to choose different type of HIGH BRIGHTNESS LED. It is suitable as accent lighting in kitchens, wardrobes, shelves, etc. It can be installed on any type of materials or surface.

- Power supply: 12/24 Vdc
- Clip included in the box.

CONNECT IN PARALLEL

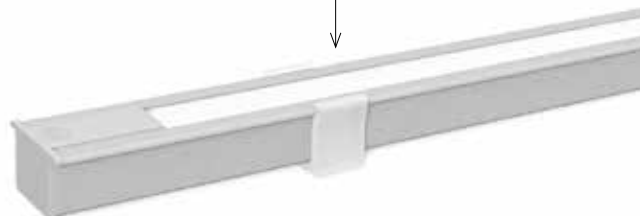
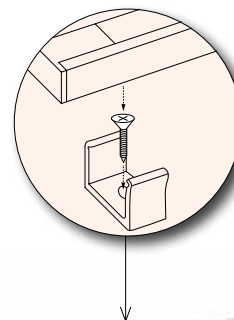

DIMENSIONI / DIMENSIONS

ACCESSORI / ACCESSORIES

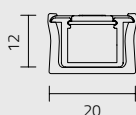

DIMENSIONE / DIMENSION
tolleranza ± 2mm / tolerance ± 2mm

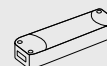
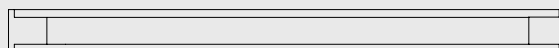

Alimentatori pag. 258-260
Drivers page 258-260

CODICI BASE / BASE CODES

FINITURE / FINISHINGS

SUPPORTI LATERALI / LATERAL SUPPORT

01.

1 Bianco RAL 9003
White RAL 9003

2 Nero opaco RAL 9005
Matt Black RAL 9005

7 Argento anodizzato
Anodized silver

1 Bianco
White

2 Nero opaco
Matt Black

7 Alluminio satinato
Satin aluminum

1 I Bianco con interruttore
White with switch

2 I Nero opaco
Matt Black

7 I Allum. satinato con interruttore
Satin aluminum with switch

1 T Bianco con touch
White with touch

2 T Nero opaco
Matt Black

7 T Allum. satinato con touch
Satin aluminum with touch

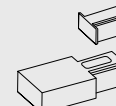
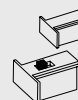
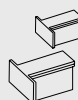

DIMENSIONI / DIMENSION

G 900mm
H 1000mm
I 1200mm
L 1500mm
M 1800mm
N 2000mm
O 2300mm
P 2500mm
Q 2800mm
R 3000mm

* Altre misure disponibili su richiesta
* More dimensions available

COLORE LED / LED COLOUR

BN 4000°K
 BC 3000°K
 CC 2700°K

* Le Strip colorate,
Bianco dinamico, RGB
sono disponibili su richiesta.

* Colored, Tunable white,
RGB strip LED available up
on request.

POTENZA / POWER

A 4,8W/m 400lm/m
B 9,6W/m 800lm/m
E 17W/m 2000lm/m
F 21W/m 2500lm/m
J+ 15W/m 1800lm/m
K+ 22W/m 2500lm/m
P+ 14W/m 1400lm/m

Esempio di codifica: Prodotto OMEGA CLIP + Finitura bianco + Supporti laterali bianco + Dimensione 900mm + Colore led 3000°K + Potenza 9,6W/m = Codice: 01.11GBNB
Example of codification: Product OMEGA CLIP + Finishing white+ Lateral support white + Dimension 900mm + Led color 3000°K + Power 9,6W/m = Code: 01.11GBNB

RHO CLIP

R3.

Estruso in alluminio anodizzato dalle dimensioni particolarmente ridotte, disegnato e prodotto per essere installato su superfici anche di spessore minimo. Estrema facilità di montaggio garantita dal diffusore satinato ad inserimento a pressione, dai supporti laterali a pressione dalle clip in policarbonato. Ideale per ospitare e dissipare correttamente strip LED, particolarmente indicato per illuminare ed impreziosire pensili da cucine e bagni, sottopensili, mobili, armadi, mensole e vetrine.

- Alimentazione: 12/24 Vdc
- Clip comprese nella confezione

COLLEGARE IN PARALLELO

Anodized aluminium extruded with very reduced dimensions, designed and produced in order to be lay-in also on surfaces with a minimum thickness. Extremely easy assembly thanks to the snap fitting satin diffuser, to the pressure lateral supports and by polycarbonate clips. Perfect solution for hold and correctly dissipate LED strip.

It is suitable for lighting and to embellish kitchens and bathrooms shelves, under-wall unit, furnitures, wardrobes, shelves and showcases.

- Power supply: 12/24 Vdc
- Clip included in the box.

CONNECT IN PARALLEL

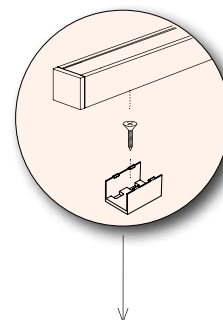

DIMENSIONI / DIMENSIONS



ACCESSORI / ACCESSORIES

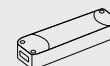

Alimentatori pag. 260
Drivers page 260

CODICI BASE / BASE CODES

R3.

FINITURE / FINISHINGS

- 1 Bianco RAL 9003
White RAL 9003
- 2 Nero opaco RAL 9005
Matt Black RAL 9005
- 7 Argento anodizzato
Anodized silver

SUPPORTI LATERALI / LATERAL SUPPORT

- 1 Bianco
White
- 2 Nero opaco
Matt Black
- 7 Alluminio satinato
Satin aluminum

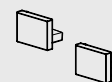

DIMENSIONI / DIMENSION

- G** 900mm
- H** 1000mm
- I** 1200mm
- L** 1500mm
- M** 1800mm
- N** 2000mm
- O** 2300mm
- P** 2500mm
- Q** 2800mm
- R** 3000mm

* Altre misure disponibili su richiesta
* More dimensions available

COLORE LED / LED COLOUR

- BN** 4000°K
 - BC** 3000°K
 - CC** 2700°K
- * Le Strip colorate, Bianco dinamico, RGB e RGBW sono disponibili su richiesta.
* Colored, Tunable white, RGB and RGBW strip LED available upon request.

POTENZA / POWER

- E** 17W/m 2000lm/m
- F** 21W/m 2500lm/m
- G** 25W/m 3500lm/m
- H** 30W/m 4500lm/m
- J+** 15W/m 1800lm/m
- K+** 22W/m 2500lm/m
- L+** 28W/m 3500lm/m
- P+** 14W/m 1400lm/m

Esempio di codifica: Prodotto RHO CLIP + Finitura bianco + Supporti laterali bianco + Dimensione 900mm + Colore led 3000°K + Potenza 17W/m = Codice: **R3.11GBNE**
Example of codification: Product RHO CLIP + Finishing white+ Lateral support white + Dimension 900mm + Led color 3000°K + Power 17W/m = Code: R3.11GBNE

YPSILON CLIP

Y2.

Estruso modulare in alluminio anodizzato dalle dimensioni particolarmente ridotte, disegnato e prodotto per essere installato su superfici anche di spessore minimo. Estrema facilità di montaggio garantita dal diffusore satinato ad inserimento a pressione, dai supporti laterali a pressione dalle clip in policarbonato e dalla cassaforma pre installata. Ideale per ospitare e dissipare correttamente strip LED, particolarmente indicato per illuminare ed impreziosire pensili da cucine e bagni, sottopensili, mobili, armadi, mensole e vetrine.

- Alimentazione: 12/24 Vdc
- Clip comprese nella confezione

COLLEGARE IN PARALLELO

Anodized aluminium extruded with very reduced dimensions, designed and produced in order to be lay-in also on surfaces with a minimum thickness. Extremely easy assembly thanks to the snap fitting satin diffuser, to the pressure lateral supports and by polycarbonate clips and by the pre-installed outer casing.

Perfect solution for hold and correctly dissipate LED strip.

It is suitable for lighting and to embellish kitchens and bathrooms shelves, under-wall unit, furnitures, wardrobes, shelves and showcases.

- Power supply: 12/24 Vdc
- Clip included in the box.

CONNECT IN PARALLEL

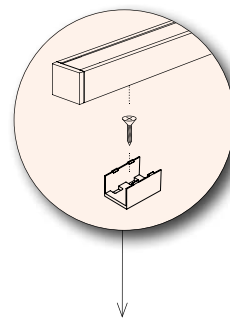

DIMENSIONI / DIMENSIONS

ACCESSORI / ACCESSORIES

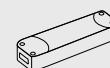

Alimentatori pag. 260
Drivers page 260

CODICI BASE / BASE CODES

Y2.

FINITURE / FINISHINGS

- 1 Bianco RAL 9003
White RAL 9003
- 2 Nero opaco RAL 9005
Matt Black RAL 9005
- 7 Argento anodizzato
Anodized silver

SUPPORTI LATERALI / LATERAL SUPPORT

- 1 Bianco
White
- 2 Nero opaco
Matt Black
- 7 Alluminio satinato
Satin aluminum

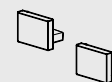

DIMENSIONI / DIMENSION

- G 900mm
- H 1000mm
- I 1200mm
- L 1500mm
- M 1800mm
- N 2000mm
- O 2300mm
- P 2500mm
- Q 2800mm
- R 3000mm

* Altre misure disponibili su richiesta
* More dimensions available

COLORE LED / LED COLOUR

- BN 4000°K
 - BC 3000°K
 - CC 2700°K
- * Le Strip colorate,
Bianco dinamico, RGB e RGBW
sono disponibili su richiesta.
- * Colored, Tunable white,
RGB and RGBW strip LED
available upon request.

POTENZA / POWER

- E 17W/m 2000lm/m
- F 21W/m 2500lm/m
- K+ 22W/m 2500lm/m

Esempio di codifica: Prodotto YPSILON CLIP + Finitura argento + Supporti laterali grigio + Dimensione 1500mm + Colore led 3000°K + Potenza 17W/m = Codice: Y2.77LBCE
Example of codification: Product YPSILON CLIP + Finishing silver + Lateral support grey + Dimension 1500mm + Led color 3000°K + Power 17W/m = Code: Y2.77LBCE

OMEGA PLAFONE

O3.

Lampada in alluminio anodizzato completa di diffusore satinato a infilare, supporti laterali e LED ad alta luminosità con elevato rapporto lumen/watt. Particolarmente adatta per illuminazione d'accento e di servizio. Indicata per arredi, residenziale, retail ed illuminotecnica.

Installabile a plafone su qualsiasi superficie.

- Montaggio a vite.
- Linea moderna ed essenziale.
- Ampia gamma di soluzioni illuminanti, dimensioni personalizzabili e controllo della luce a bordo lampada.
- Alimentazione: 12/24Vdc.

COLLEGARE IN PARALLELO

Anodized aluminium lamp complete with satin diffuser, lateral supports and high brightness LED with very good relation between Lumen/Watt. It is suitable as accent and service lighting, on furnishings, for residential locations, retail and for lighting technique. It can be ceiling recessed on any type of surface.

- Spring assembly.
- Modern and essential design.
- Wide range of lighting solutions, customizing dimensions and control of the light on lamp border.
- Power supply: 12/24Vdc

CONNECT IN PARALLEL

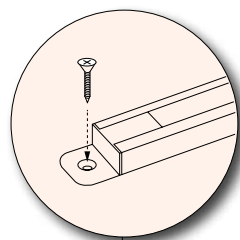

DIMENSIONI / DIMENSIONS

ACCESSORI / ACCESSORIES

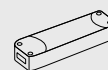

Alimentatori pag. 258-260
Drivers page 258-260

CODICI BASE / BASE CODES

FINITURE / FINISHINGS

SUPPORTI LATERALI / LATERAL SUPPORT

O3.

- | | | | |
|--|---|--|---|
| <input type="checkbox"/> 1 Bianco RAL 9003
White RAL 9003 | <input type="checkbox"/> 1 Bianco
White | <input type="checkbox"/> 1 I Bianco con interruttore
White with switch | <input type="checkbox"/> 1T Bianco con touch
White with touch |
| <input checked="" type="checkbox"/> 2 Nero opaco RAL 9005
Matt Black RAL 9005 | <input checked="" type="checkbox"/> 2 Nero opaco
Matt Black | <input checked="" type="checkbox"/> 2 I Nero opaco
Matt Black | <input checked="" type="checkbox"/> 2T Nero opaco
Matt Black |
| <input type="checkbox"/> 7 Argento anodizzato
Anodized silver | <input type="checkbox"/> 7 Alluminio satinato
Satin aluminum | <input type="checkbox"/> 7 I Alluminio satinato con interruttore
Satin aluminum with switch | <input type="checkbox"/> 7T Alluminio satinato con touch
Satin aluminum with touch |

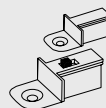
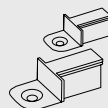

DIMENSIONI / DIMENSION

COLORE LED / LED COLOUR

POTENZA / POWER

- G 900mm
- H 1000mm
- I 1200mm
- L 1500mm
- M 1800mm
- N 2000mm
- O 2300mm
- P 2500mm
- Q 2800mm
- R 3000mm

- BN 4000°K
- BC 3000°K
- CC 2700°K
- * Le Strip colorate, Bianco dinamico e RGB sono disponibili su richiesta.
- * Colored, Tunable white, and RGB strip LED available upon request.

- A 4,8W/m 400lm/m
- B 9,6W/m 800lm/m
- E 17W/m 2000lm/m
- F 21W/m 2500lm/m
- J+ 15W/m 1800lm/m
- K+ 22W/m 2500lm/m
- P+ 14W/m 1400lm/m

* Altre misure disponibili su richiesta
* More dimensions available

Esempio di codifica: Prodotto OMEGA PLAFONE + Finitura bianco + Supporti laterali bianco + Dimensione 900mm + Colore led 3000°K + Potenza 4,8W/m = Codice: R3.11GBNA
Example of codification: Product OMEGA PLAFONE + Finishing white+ Lateral support white + Dimension 900mm + Led color 3000°K + Power 4,8W/m = Code: R3.11GBNA

ALFA 1 PLAFONE

A1.

Lampada in alluminio anodizzato completa di diffusore satinato a infilare, supporti laterali e LED ad alta luminosità con elevato rapporto Lumen/Watt. Particolarmente adatta per illuminazione d'accento e di servizio. Indicata per arredi, residenziale, retail ed illuminotecnica in genere. Installabile a plafone su qualsiasi superficie.

- Montaggio con vite a scomparsa.
- Linea moderna ed essenziale.
- Ampia gamma di soluzioni illuminanti, dimensioni personalizzabili e controllo della luce a bordo lampada.
- Alimentazione: 12/24Vdc.
- Molle comprese nella confezione

COLLEGARE IN PARALLELO

Anodized Aluminium lamp complete with satin diffuser, lateral supports and high brightness LED with very good relation between Lumen/Watt. It is suitable as accent and service lightin, on furnishings, for residential locations, retail and for lighting technique.

It can be ceiling recessed on any type of surface.

- Hidden spring assembly.
- Modern and essential design.
- Wide range of lighting solutions, customizing dimensions and control of the light on lamp border.
- Power supply: 12/24Vdc
- Steel springs included in the box.

CONNECT IN PARALLEL

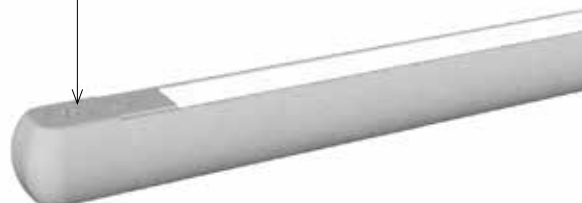
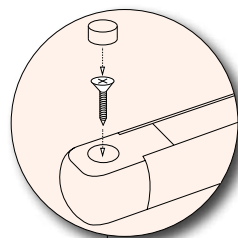

DIMENSIONI / DIMENSIONS



ACCESSORI / ACCESSORIES

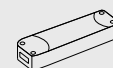

Alimentatori pag. 258-260
Drivers page 258-260

CODICI BASE / BASE CODES

A1.

FINITURE / FINISHINGS

- 1 Bianco RAL 9003
White RAL 9003
- 2 Nero opaco RAL 9005
Matt Black RAL 9005
- 7 Argento anodizzato
Anodized silver

SUPPORTI LATERALI / LATERAL SUPPORT

- 1 Bianco
White
- 2 Nero opaco
Matt Black
- 7 Alluminio satinato
Satin aluminum
- 1 I Bianco con interruttore
White with switch
- 2 I Nero opaco
Matt Black
- 7 I Allum. satinato con interruttore
Satin aluminum with switch
- 1 T Bianco con touch
White with touch
- 2 T Nero opaco
Matt Black
- 7 T Allum. satinato con touch
Satin aluminum with touch

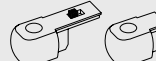

SUPPORTI LATERALI / LATERAL SUPPORT

- 1 S Bianco con sensore
White with sensor
- 2 S Nero opaco
Matt Black
- 7 S Grigio con sensore
Grey with sensor



DIMENSIONI / DIMENSION

- G** 900mm
- H** 1000mm
- I** 1200mm
- L** 1500mm
- M** 1800mm
- N** 2000mm
- O** 2300mm
- P** 2500mm
- Q** 2800mm
- R** 3000mm

* Altre misure disponibili su richiesta
* More dimensions available

COLORE LED / LED COLOUR

- BN 4000°K
 - BC 3000°K
 - CC 2700°K
- * Le Strip colorate, Bianco dinamico, RGB e RGBW sono disponibili su richiesta.
* Colored, Tunable white, RGB and RGBW strip LED available upon request.

POTENZA / POWER

- A** 4,8W/m 400lm/m
- B** 9,6W/m 800lm/m
- E** 17W/m 2000lm/m
- F** 21W/m 2500lm/m
- G** 25W/m 3500lm/m
- J+** 15W/m 1800lm/m
- K+** 22W/m 2500lm/m
- L+** 28W/m 3500lm/m
- P+** 14W/m 1400lm/m

Esempio di codifica: Prodotto ALFA1 PLAFONE + Finitura bianco + Supporti laterali bianco + Dimensione 900mm + Colore led 3000°K + Potenza 4,8W/m = Codice: **A1.11GBNA**
Example of codification: Product ALFA1 PLAFONE + Finishing white+ Lateral support white + Dimension 900mm + Led color 3000°K + Power 4,8W/m = Code: A1.11GBNA

ALFA 2 PLAFONE

A2.

Lampada in alluminio anodizzato completa di diffusore satinato a pressione, supporti laterali e LED ad alta luminosità con elevato rapporto Lumen/Watt. Particolarmente adatta per illuminazione d'accento e di servizio. Indicata per arredi, residenziale, retail ed illuminotecnica in genere. Installabile a plafone su qualsiasi superficie.

- Montaggio con clip a scomparsa.
- Linea moderna ed essenziale.
- Diffusore a scatto con effetto "Full-Light".
- Ampia gamma di soluzioni illuminanti, dimensioni personalizzabili e controllo della luce a bordo lampada.
- Alimentazione: 12/24Vdc.
- Molle comprese nella confezione

COLLEGARE IN PARALLELO

Anodized Aluminium lamp complete with satin diffuser, lateral supports and high brightness LED with very good relation between Lumen/Watt. It is suitable as accent and service lighting, on furnishings, for residential locations, retail and for lighting technique. It can be ceiling recessed on any type of surface.

- Hidden spring assembly. Modern and essential design.
- Diffuser with snap fitting and with Full-Light effect.
- Wide range of lighting solutions, customizing dimensions and control of the light on lamp border.
- Power supply: 12/24Vdc.
- Steel springs included in the box.

CONNECT IN PARALLEL

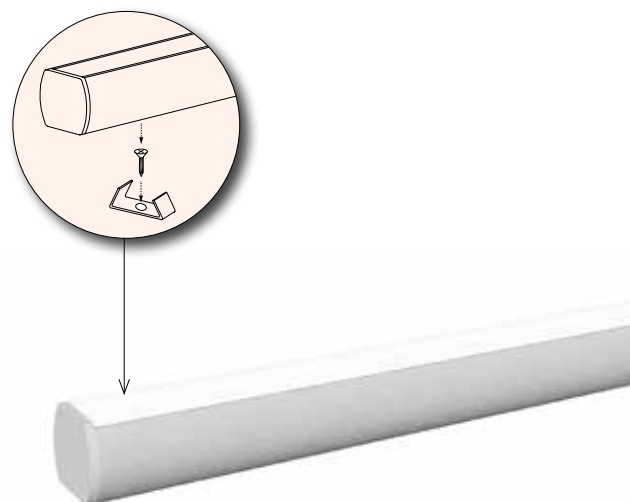

DIMENSIONI / DIMENSIONS

ACCESSORI / ACCESSORIES

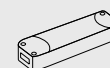

Alimentatori pag. 258-260
Drivers page 258-260

CODICI BASE / BASE CODES

FINITURE / FINISHINGS

SUPPORTI LATERALI / LATERAL SUPPORT

A2.

- 1 Bianco RAL 9003
White RAL 9003
- 2 Nero opaco RAL 9005
Matt Black RAL 9005
- 7 Argento anodizzato
Anodized silver

- 1 Bianco
White
- 2 Nero opaco
Matt Black
- 7 Alluminio satinato
Satin aluminium
- 1T Bianco con touch
White with touch
- 2T Nero opaco
Matt Black
- 7T Alluminio satinato con touch
Satin aluminium with touch

- 1S Bianco con sensore
White with sensor
- 2S Nero opaco
Matt Black
- 7S Allum. satinato con sensore
Satin alu. with with sensor

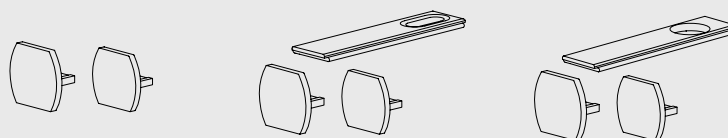

DIMENSIONI / DIMENSION

COLORE LED / LED COLOUR

POTENZA / POWER

- G** 900mm
- H** 1000mm
- I** 1200mm
- L** 1500mm
- M** 1800mm
- N** 2000mm
- O** 2300mm
- P** 2500mm
- Q** 2800mm
- R** 3000mm

- BN 4000°K
- BC 3000°K
- CC 2700°K
- * Le Strip colorate,
Bianco dinamico, RGB e RGBW
sono disponibili su richiesta.
- * Colored, Tunable white,
RGB and RGBW strip LED
available upon request.

- A** 4,8W/m 400lm/m
- B** 9,6W/m 800lm/m
- E** 17W/m 2000lm/m
- F** 21W/m 2500lm/m
- G** 25W/m 3500lm/m
- J+** 15W/m 1800lm/m
- K+** 22W/m 2500lm/m
- L+** 28W/m 3500lm/m
- P+** 14W/m 1400lm/m

* Altre misure disponibili su richiesta
* More dimensions available

Esempio di codifica: Prodotto ALFA2 PLAFONE + Finitura bianco + Supporti laterali bianco + Dimensione 900mm + Colore led 3000°K + Potenza 4,8W/m = Codice: **A2.11GBNA**
Example of codification: Product ALFA2 PLAFONE + Finishing white+ Lateral support white + Dimension 900mm + Led color 3000°K + Power 4,8W/m = Code: A2.11GBNA

ZETA PLAFONE

Z1.

Estruso in alluminio anodizzato dalle dimensioni particolarmente ridotte, disegnato e prodotto per essere appoggiato su superfici anche di spessore minimo.

Estrema facilità di montaggio garantita dal diffusore satinato ad inserimento a infilare e dai supporti laterali a pressione.

Ideale per ospitare e dissipare correttamente Strip LED, particolarmente indicato per illuminare ed impreziosire pensili di cucine e bagni, sottopensili, mobili, armadi, mensole e vetrine.

Può essere montato anche su cartongesso ed a plafone.

- Alimentazione: 12/24Vdc.

COLLEGARE IN PARALLELO

Anodized Aluminium extruded with very reduced dimensions, designed and produced in order to be lay-in also on surfaces with a minimum thickness.

Extremely easy assembly thanks to the snap fitting satin diffuser and to the pressure lateral supports.

Perfect solution for hold and correctly dissipate LED strip.

It is suitable for lighting and to embellish kitchens and bathrooms shelves, under-wall unit, furnitures, wardrobes, shelves and showcases.

It can be also ceiling or dry wall recessed.

- Power supply: 12/24Vdc.

CONNECT IN PARALLEL

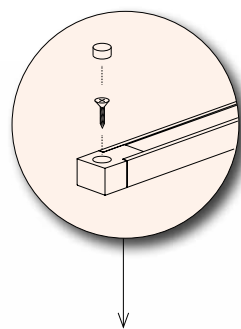

DIMENSIONI / DIMENSIONS



ACCESSORI / ACCESSORIES

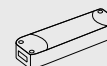

Alimentatori pag. 258-260
Drivers page 258-260

CODICI BASE / BASE CODES

Z1.

FINITURE / FINISHINGS

- 1 Bianco RAL 9003
White RAL 9003
- 2 Nero opaco RAL 9005
Matt Black RAL 9005
- 7 Argento anodizzato
Anodized silver

SUPPORTI LATERALI / LATERAL SUPPORT

- 1 Bianco
White
- 2 Nero opaco
Matt Black
- 7 Alluminio satinato
Satin aluminum
- 1 I Bianco con interruttore
White with switch
- 2 I Nero opaco
Matt Black
- 7 I Allum. satinato con interruttore
Satin aluminum with switch
- 1 T Bianco con touch
White with touch
- 2 T Nero opaco
Matt Black
- 7 T Allum. satinato con touch
Satin aluminum with touch

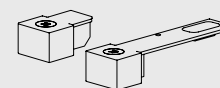
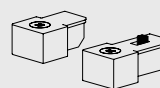
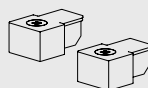

SUPPORTI LATERALI / LATERAL SUPPORT

- 1S Bianco con sensore
White with sensor
- 2S Nero opaco con sensore
Matt Black with sensor
- 7S Grigio con sensore
Grey with sensor
- 1IR Bianco con infrarosso
White with infrared
- 2IR Nero opaco con infrarosso
Matt Black with infrared
- 7IR Grigio con infrarosso
Grey with infrared

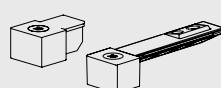
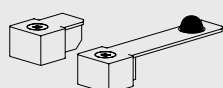

DIMENSIONI / DIMENSION

- G 900mm
- H 1000mm
- I 1200mm
- L 1500mm
- M 1800mm
- N 2000mm
- O 2300mm
- P 2500mm
- Q 2800mm
- R 3000mm

* Altre misure disponibili su richiesta
* More dimensions available

COLORE LED / LED COLOUR

- BN 4000°K
 - BC 3000°K
 - CC 2700°K
- * Le Strip colorate, Bianco dinamico, RGB e RGBW sono disponibili su richiesta.
* Colored, Tunable white, RGB and RGBW strip LED available upon request.

POTENZA / POWER

- A 4,8W/m 400lm/m
- B 9,6W/m 800lm/m
- E 17W/m 2000lm/m
- F 21W/m 2500lm/m
- G 25W/m 3500lm/m
- J+ 15W/m 1800lm/m
- K+ 22W/m 2500lm/m
- L+ 28W/m 3500lm/m
- P+ 14W/m 1400lm/m

Esempio di codifica: Prodotto ZETA PLAFONE + Finitura argento + Supporti laterali grigio con sensore + Dimensione 1500mm + Colore led 3000°K + Potenza 4,8W = Codice: Z1.77SLBCA
Example of codification: Product ZETA PLAFONE + Finishing silver + Lateral support grey with sensor + Dimension 1500mm + Led color 3000°K + Power 4,8W/m = Code: Z1.77SLBCA

GAMMA PLAFONE

G1.

Lampada in Alluminio anodizzato completa di diffusore satinato a pressione, supporti laterali e LED ad alta luminosità con elevato rapporto Lumen/Watt. Particolarmente adatta per illuminazione d'accento e di servizio. Indicata per arredi, residenziale, retail ed illuminotecnica in genere. Installabile a plafone su qualsiasi superficie. Montaggio con clip a vite. Linea essenziale e moderna.

- Diffusore a scatto con effetto "Full-Light".
- Ampia gamma di soluzioni illuminanti, dimensioni personalizzabili e controllo della luce a bordo lampada.
- Alimentazione: 12/24Vdc.
- Clip comprese nella confezione

COLLEGARE IN PARALLELO

Anodized Aluminium lamp complete with satin diffuser, lateral supports and high brightness LED with very good relation between Lumen/Watt. It is suitable as accent and service lightin, on furnishings, for residential locations, retail and for lighting technique.

It can be ceiling recessed on any type of surface.

- *Spring clip assembly. Modern and essential design.*
- *Diffuser with snap fitting and with Full-Light effect. Wide range of lighting solutions, customizing dimensions and control of the light on lamp border.*
- *Power supply: 12/24Vdc.*
- *Clip included in the box.*

CONNECT IN PARALLEL

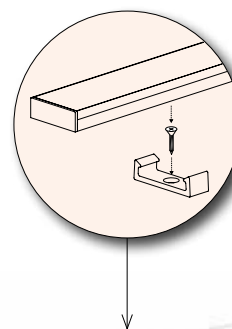

DIMENSIONI / DIMENSIONS



ACCESSORI / ACCESSORIES

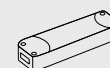

Alimentatori pag. 260
Drivers page 260

CODICI BASE / BASE CODES

G1.

FINITURE / FINISHINGS

- 1 Bianco RAL 9003
White RAL 9003
- 2 Nero opaco RAL 9005
Matt Black RAL 9005
- 7 Argento anodizzato
Anodized silver

SUPPORTI LATERALI / LATERAL SUPPORT

- 1 Bianco
White
- 2 Nero opaco
Matt Black
- 7 Alluminio satinato
Satin aluminum
- 1T Bianco con touch
White with touch
- 2T Nero opaco
Matt Black
- 7T Alluminio satinato con touch
Satin aluminum with touch

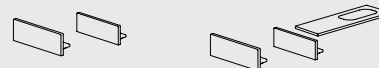

DIMENSIONI / DIMENSION

- G** 900mm
- H** 1000mm
- I** 1200mm
- L** 1500mm
- M** 1800mm
- N** 2000mm
- O** 2300mm
- P** 2500mm
- Q** 2800mm
- R** 3000mm

COLORE LED / LED COLOUR

- BN 4000°K
- BC 3000°K
- CC 2700°K
- * Le Strip colorate,
Bianco dinamico, RGB e RGBW
sono disponibili su richiesta.
- * Colored, Tunable white,
RGB and RGBW strip LED
available upon request.

POTENZA / POWER

- E** 17W/m 2000lm/m
- F** 21W/m 2500lm/m
- G** 25W/m 3500lm/m
- H** 30W/m 4500lm/m
- K+** 22W/m 2500lm/m
- L+** 28W/m 3500lm/m

* Altre misure disponibili su richiesta
* More dimensions available

Esempio di codifica: Prodotto GAMMA PLAFONE + Finitura bianco + Supporti laterali bianco + Dimensione 900mm + Colore led 4000°K + Potenza 17W/m = Codice: G1.11GBNE
Example of codification: Product GAMMA PLAFONE + Finishing white + Lateral support white + Dimension 900mm + Led color 4000° + Power 17W/m = Code: G1.11GBNE

VEGA

VG1.

Lampada in Alluminio anodizzato completa di diffusore satinato, calamita a LED ad alta luminosità con elevato rapporto Lumen/Watt. Particolarmente adatta per illuminazione d'accento e di servizio. Emissione della luce a 45°. Indicata per arredi, residenziale, retail ed illuminotecnica in genere. Installabile a plafone su qualsiasi superficie ferrosa grazie alle pratiche calamite e clip incluse posizionate nella parte posteriore del profilo. Linea essenziale e moderna. Diffusore a pressione effetto "full-light".

Ampla gamma di soluzioni illuminanti e dimensioni personalizzabili.

- Alimentazione: 24Vdc.
- Clip incluse.

COLLEGARE IN PARALLELO

Anodized aluminium lamp complete with satin diffuser, magnets and high brightness LED with very good relation between Lumen/Watt. It is suitable as accent and service lighting. Light emission 45°. It is suitable for furnishings, for residential locations, retail and for lighting technique. It can be installed on the ceiling on any ferrous surface thanks to the practical magnets positioned at the back of the profile. Modern and essential design. Diffuser with snap fitting and with "Full-light" effect. Wide range of lighting solutions and customizing dimensions.

- Power supply: 24Vdc
- Clip included in the box.

CONNECT IN PARALLEL



DIMENSIONI / DIMENSIONS

NOTE / NOTE

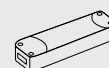
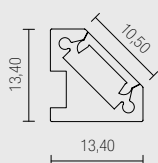

Alimentatori pag. 260
Drivers page 260

CODICI BASE / BASE CODES

FINITURE / FINISHINGS

SUPPORTI LATERALI / LATERAL SUPPORT

VG1.

- 1 Bianco RAL 9003
White RAL 9003
- 2 Nero opaco RAL 9005
Matt Black RAL 9005
- 7 Argento anodizzato
Anodized silver

- 1 Bianco
White
- 2 Nero opaco
Matt Black
- 7 Alluminio satinato
Satin aluminum

- 1T Bianco con touch
White with touch
- 2T Nero opaco
Matt Black
- 7T Alluminio satinato con touch
Satin aluminum with touch

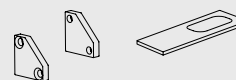

DIMENSIONI / DIMENSION

COLORE LED / LED COLOUR

POTENZA / POWER

- G 900mm
- H 1000mm
- I 1200mm
- L 1500mm
- M 1800mm
- N 2000mm
- O 2300mm
- P 2500mm
- Q 2800mm
- R 3000mm

- BN 4000°K
- BC 3000°K
- CC 2700°K

* Le Strip colorate, Bianco dinamico e RGB sono disponibili su richiesta.

* Colored, Tunable white and RGB strip LED available upon request.

- E 17W/m 2000lm/m
- F 21W/m 2500lm/m
- G 25W/m 3500lm/m
- H 30W/m 4500lm/m
- K+ 22W/m 2500lm/m
- L+ 28W/m 3500lm/m
- P+ 14W/m 1400lm/m

* Altre misure disponibili su richiesta
* More dimensions available

Esempio di codifica: Prodotto VEGA + Finitura bianco + Supporti laterali bianco + Dimensione 900mm + Colore led 4000°K + Potenza 17W/m = Codice: VG1.11GBNE

Example of codification: Product VEGA + Finishing white + Lateral support white + Dimension 900mm + Led color 4000° + Power 17W/m = Code: VG1.11GBNE

BETA PLAFONE

B1.

Lampada in alluminio anodizzato completa di diffusore satinato a pressione, supporti laterali e LED ad alta luminosità con elevato rapporto Lumen/Watt. Particolarmente adatta per illuminazione d'accento e di servizio. Emissione della luce a 45°. Indicata per arredi, residenziale, retail ed illuminotecnica in genere. Installabile a plafone su qualsiasi superficie.

- Montaggio con clip a vite comprese nell confezione.
- Linea essenziale e moderna. Diffusore a scatto con effetto "Full-Light". Ampia gamma di soluzioni illuminanti, dimensioni personalizzabili e controllo della luce a bordo lampada.
- Alimentazione: 12/24Vdc.

COLLEGARE IN PARALLELO

Anodized Aluminium lamp complete with satin diffuser, lateral supports and high brightness LED with very good relation between Lumen/Watt. It is suitable as accent and service lightin. Light emission 45°. It is suitable for furnishings, for residential locations, retail and for lighting technique. It can be ceiling recessed on any type of surface.

- Spring clip assembly included in the box.
- Modern and essential design.
- Diffuser with snap fitting and with Full-Light effect. Wide range of lighting solutions, customizing dimensions and control of the light on lamp border.
- Power supply: 12/24Vdc.

CONNECT IN PARALLEL

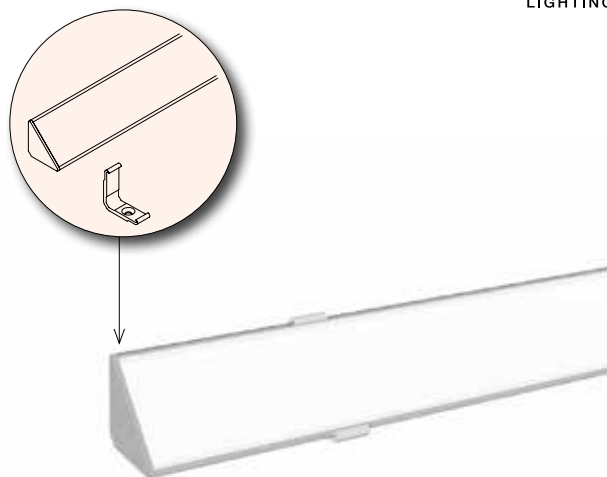

DIMENSIONI / DIMENSIONS

ACCESSORI / ACCESSORIES

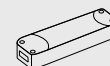

Alimentatori pag. 260
Drivers page 260

CODICI BASE / BASE CODES

FINITURE / FINISHINGS

SUPPORTI LATERALI / LATERAL SUPPORT

B1.

- 1 Bianco RAL 9003
White RAL 9003
- 2 Nero opaco RAL 9005
Matt Black RAL 9005
- 7 Argento anodizzato
Anodized silver

- 1 Bianco
White
- 2 Nero opaco
Matt Black
- 7 Alluminio satinato
Satin aluminum

- 1T Bianco con touch
White with touch
- 2T Nero opaco
Matt Black
- 7T Alluminio satinato con touch
Satin aluminum with touch

- 1IR Bianco con infrarod
White with infrared
- 2IR Nero opaco con infrarod
Matt Black with infrared
- 7IR Alluminio satinato con infrarod
Satin aluminum with infrared



DIMENSIONI / DIMENSION

- G 900mm
- H 1000mm
- I 1200mm
- L 1500mm
- M 1800mm
- N 2000mm
- O 2300mm
- P 2500mm
- Q 2800mm
- R 3000mm

COLORE LED / LED COLOUR

- BN 4000°K
- BC 3000°K
- CC 2700°K
- * Le Strip colorate,
Bianco dinamico, RGB e RGBW
sono disponibili su richiesta.
- * Colored, Tunable white,
RGB and RGBW strip LED
available upon request.

POTENZA / POWER

- E 17W/m 2000lm/m
- F 21W/m 2500lm/m
- G 25W/m 3500lm/m
- H 30W/m 4500lm/m
- K+ 22W/m 2500lm/m
- L+ 28W/m 3500lm/m

* Altre misure disponibili su richiesta
* More dimensions available

Esempio di codifica: Prodotto BETA PLAFONE + Finitura bianco + Supporti laterali bianco + Dimensione 900mm + Colore Led 4000°K + Potenza 17W/m = Codice: B1.11GRGBE
Example of codification: Product BETA PLAFONE + Finishing white + Lateral support white + Dimension 900mm + Led color 4000°K+ Power 17W/m = Code: B1.11GRGBE

VIRGO IR

V2.

Lampada a plafone in alluminio con LED ad alta luminosità. Schermo a pressione. Indicata come lampada di servizio per arredi. Installabile in ambienti interni. Montaggio con molle a scomparsa nel corpo lampada. La tecnologia ad infrarossi riconosce immediatamente uno scostamento di pochi centimetri permettendo l'accensione e lo spegnimento ogni qual volta l'utente apra o chiuda l'anta di un'armadio o il cassetto di una cucina.

Se un cassetto o un'anta rimane aperto per più di 3 minuti il sensore ad infrarossi spegnerà automaticamente la lampada.

- Alimentazione: 12/24 Vdc - 6,5A Max.
- Molle comprese nella confezione.

COLLEGARE IN PARALLELO

Ceiling aluminium lamp with high brightness LED.

It is suitable as service light for furnishings. It can be installed on indoor locations. Assembly with hidden springs. Infrared technology recognizes immediately a deviation of a few centimeters allowing the switching on e switching off whenever the user opens or closes the door of a wardrobe or a kitchen drawer.

If a drawer or door remains open for more than 3 minutes the infrared sensor will automatically turn off the lamp.

- Power supply: 12/24Vdc - 6,5A Max
- Steel springs included in the box.

CONNECT IN PARALLEL

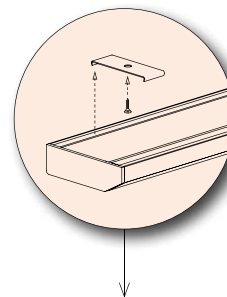

DIMENSIONI / DIMENSIONS

NOTE / NOTE

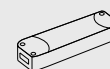
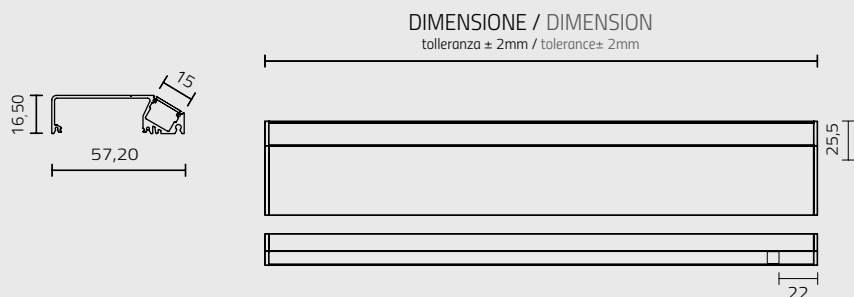

Alimentatori pag. 258-260
Drivers page 258-260

CODICI BASE / BASE CODES

V2.

FINITURE / FINISHINGS

- 1 Bianco RAL 9003
White RAL 9003
- 2 Nero opaco RAL 9005
Matt Black RAL 9005
- 7 Argento anodizzato
Anodized silver

SUPPORTI LATERALI / LATERAL SUPPORT

- 1 Bianco
White
- 2 Nero opaco
Matt Black
- 7 Alluminio satinato
Satin aluminum

- 1T Bianco
White
- 2T Nero opaco
Matt Black
- 7T Alluminio satinato
Satin aluminum

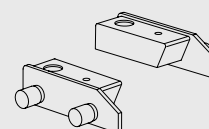
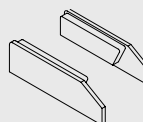

DIMENSIONI / DIMENSION

- G 900mm
- H 1000mm
- I 1200mm
- L 1500mm
- M 1800mm
- N 2000mm
- O 2300mm
- P 2500mm
- Q 2800mm
- R 3000mm

* Altre misure disponibili su richiesta
* More dimensions available

COLORE LED / LED COLOUR

- BN 4000°K
- BC 3000°K
- CC 2700°K

* Le Strip colorate, sono disponibili su richiesta.

* Colored strip LED available upon request.

POTENZA / POWER

- A 4,8W/m 400lm/m
- B 9,6W/m 800lm/m
- C 9,6W/m 800lm/m
- E 17W/m 2000lm/m
- J+ 15W/m 1800lm/m
- K+ 22W/m 2500lm/m

Esempio di codifica: Prodotto VIRGO INFRARED + Finitura bianco + Supporti laterali bianco + Dimensione 1500mm + Colore led 4000°K + Potenza 4,8W/m = Codice: V2.11LBNA
Example of codification: Product VIRGO INFRARED + Finishing white + Lateral support white + Dimension 1500mm + Led color 4000°K + Power 4,8W/m = Code: V2.11LBNA

VIRGO PIR

V1.

Lampada a plafone in alluminio con LED ad alta luminosità.
Schermo a pressione. Indicata come lampada di servizio per arredi.
Installabile in ambienti interni.
Montaggio con molle a scomparsa nel corpo lampada.
La tecnologia ad infrarossi riconosce immediatamente uno scostamento di pochi centimetri permettendo l'accensione e lo spegnimento ogni qual volta l'utente apra o chiuda l'anta di un'armadio o il cassetto di una cucina.

Se un cassetto o un'anta rimane aperto per più di 3 minuti il sensore ad infrarossi spegnerà automaticamente la lampada.

- Alimentazione: 12/24 Vdc - 6,5A Max.
- Molle comprese nella confezione.

COLLEGARE IN PARALLELO

Ceiling aluminium lamp with high brightness LED.

It is suitable as service light for furnishings. It can be installed on indoor locations. Assembly with hidden springs. Infrared technology recognizes immediately a deviation of a few centimeters allowing the switching on e switching off whenever the user pens r closes the door of a wardrobe or a kitchen drawer.

If a drawer or door remains open for more than 3 minutes the infrard sensor will automatically turn off he lamp.

- Power supply: 12/24Vdc - 6,5A Max
- Steel springs included in the box.

CONNECT IN PARALLEL

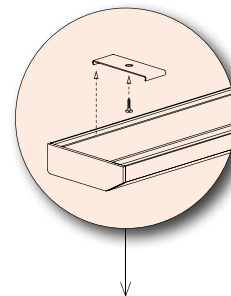

DIMENSIONI / DIMENSIONS

NOTE / NOTE

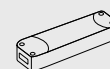

Alimentatori pag. 258-260
Drivers page 258-260

CODICI BASE / BASE CODES

FINITURE / FINISHINGS

SUPPORTI LATERALI / LATERAL SUPPORT

V1.

- 1 Bianco RAL 9003
White RAL 9003
- 2 Nero opaco RAL 9005
Matt Black RAL 9005
- 7 Argento anodizzato
Anodized silver

- 1 Bianco
White
- 2 Nero opaco
Matt Black
- 7 Alluminio satinato
Satin aluminum

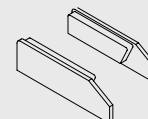

DIMENSIONI / DIMENSION

COLORE LED / LED COLOUR

POTENZA / POWER

- G 900mm
- H 1000mm
- I 1200mm
- L 1500mm
- M 1800mm
- N 2000mm
- O 2300mm
- P 2500mm
- Q 2800mm
- R 3000mm

- BN 4000°K
- BC 3000°K
- CC 2700°K
- * Le Strip colorate sono disponibili su richiesta.
- * Colored strip LED available upon request.

- A 4,8W/m 400lm/m
- B 9,6W/m 800lm/m
- C 9,6W/m 800lm/m
- E 17W/m 2000lm/m
- J+ 15W/m 1800lm/m
- K+ 22W/m 2500lm/m

* Altre misure disponibili su richiesta
* More dimensions available

Esempio di codifica: Prodotto VIRGO PIR + Finitura bianco + Supporti laterali bianco + Dimensione 1500mm + Colore led 4000°K + Potenza 4,8W/m = Codice: V1.11LBNA
Example of codification: Product VIRGO PIR + Finishing white + Lateral support white + Dimension 1500mm + Led color 4000°K + Power 4,8W/m = Code: V1.11LBNA

DELTA PLAFONE

D1.

Lampada in alluminio anodizzato completa di diffusore satinato a pressione, supporti laterali e LED ad alta luminosità con elevato rapporto Lumen/Watt. Particolarmente adatta come illuminazione primaria per residenziale, retail, grandi ambienti ed illuminotecnica in genere.

Installabile a plafone su qualsiasi superficie.

- Montaggio con clip a scomparsa. Linea classica e funzionale.
- Diffusore a scatto con effetto "Full-Light".
- Ampia gamma di soluzioni illuminanti, dimensioni personalizzabili.
- Alimentazione: 24Vdc.
- Molle comprese nella confezione.

COLLEGARE IN PARALLELO

Anodized aluminium lamp complete with satin diffuser, lateral supports and high brightness LED with very good relation between Lumen/Watt. It is suitable as main light in for residential and wide locations, retail and for lighting technique. It can be ceiling recessed on any type of surface.

- *Hidden clip assembly.*
- *Modern and essential design. Diffuser with snap fitting and with Full-Light effect. Wide range of lighting solutions, customizing dimensions and control of the light on lamp border.*
- *Power supply: 24Vdc*
- *Steel springs included in the box*

CONNECT IN PARALLEL

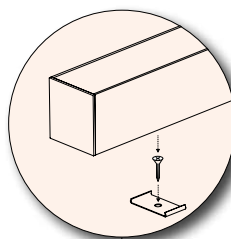

DIMENSIONI / DIMENSIONS

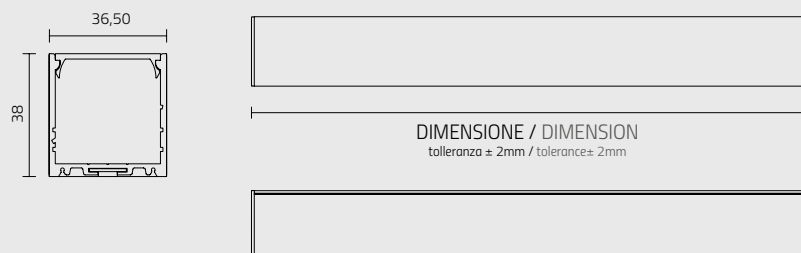

ACCESSORI / ACCESSORIES

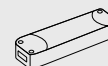

Alimentatori pag. 260
Drivers page 260

CODICI BASE / BASE CODES

D1.

FINITURE / FINISHINGS

- 1 Bianco RAL 9003
White RAL 9003
- 2 Nero opaco RAL 9005
Matt Black RAL 9005
- 7 Argento anodizzato
Anodized silver

SUPPORTI LATERALI / LATERAL SUPPORT

- 1 Bianco
White
- 2 Nero opaco
Matt Black
- 7 Alluminio satinato
Satin aluminum

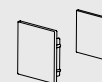

COLORE LED / LED COLOUR

- BN 4000°K
- BC 3000°K
- CC 2700°K
- * Le Strip colorate, Bianco dinamico, RGB e RGBW sono disponibili su richiesta.
- * Colored, Tunable white, RGB and RGBW strip LED available upon request.

POTENZA / POWER

- G** 25W/m 3500lm/m
- H** 30W/m 4500lm/m
- I** 40W/m 6000lm/m
- L+** 28W/m 3500lm/m
- M+** 40W/m 5000lm/m

- G** 900mm
- H** 1000mm
- I** 1200mm
- L** 1500mm
- M** 1800mm
- N** 2000mm
- O** 2300mm
- P** 2500mm
- Q** 2800mm
- R** 3000mm

* Altre misure disponibili su richiesta
* More dimensions available

Esempio di codifica: Prodotto D1 + Finitura argento + Supporti laterali grigi + Dimensione 3000mm + Colore led 3000°K + Potenza 25W/m = Codice: **D1.77RBCG**
Example of codification: Product D1 + Finishing silver + Lateral support grey + Dimension 3000mm + Led color 3000°K + Power 25W/m = Code: D1.77RBCG

KAPPA PLAFONE

K3.

Lampada a plafone in alluminio anodizzato completa di diffusori satinati a pressione, supporti laterali, tasselli di fissaggio ed alimentazione integrata. LED ad alta luminosità con elevato rapporto Lumen/Watt. Particolarmente adatta come illuminazione primaria per residenziale, retail, grandi ambienti ed illuminotecnica in genere. Installabile a plafone su qualsiasi superficie.

- Montaggio con tasselli in alluminio e viti.
 - Linea essenziale e moderna. Diffusore a scatto con effetto "Full-Light". Ampia gamma di soluzioni illuminanti, dimensioni personalizzabili.
 - Alimentazione: 220V.
 - Blocchetti inclusi nella confezione + Alimentatore
- COLLEGARE IN PARALLELO

Anodized aluminium ceiling lamp complete with satin diffuser, lateral supports, fixing elements and integrated power supply. High brightness LED with very good relation between Lumen/Watt. It is suitable as main light for residential and wide locations, retail and for lighting technique. It can be ceiling installed on any type of surface.

- Aluminium elements and screws assembly.
- Modern and essential design. Diffuser with snap fitting and with Full-Light effect. Wide range of lighting solutions, customizing dimensions and control of the light on lamp border.
- Power supply: 220V
- Aluminium blocks included in the box + Drivers
- CONNECT IN PARALLEL

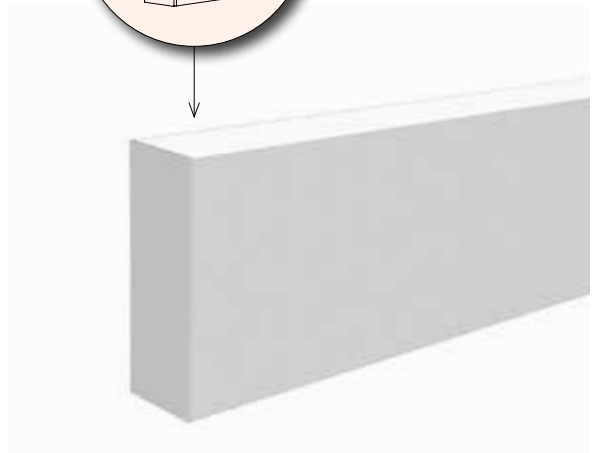
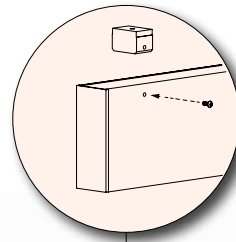

DIMENSIONI / DIMENSIONS



CODICI BASE / BASE CODES

K3.

FINITURE / FINISHINGS

- 1 Bianco RAL 9003
White RAL 9003
- 2 Nero opaco RAL 9005
Matt Black RAL 9005
- 7 Argento anodizzato
Anodized silver

SUPPORTI LATERALI / LATERAL SUPPORT

- 1 Bianco
White
- 2 Nero opaco
Matt Black
- 7 Alluminio satinato
Satin aluminum

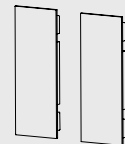

DIMENSIONI / DIMENSION

- D 600mm
- G 900mm
- H 1000mm
- I 1200mm
- L 1500mm
- M 1800mm
- N 2000mm
- O 2300mm
- P 2500mm
- Q 2800mm
- R 3000mm

COLORE LED / LED COLOUR

- BN 4000°K
- BC 3000°K
- CC 2700°K
- * Le Strip colorate, Bianco dinamico, RGB e RGBW sono disponibili su richiesta.
- * Colored, Tunable white, RGB and RGBW strip LED available upon request.

POTENZA / POWER

- G 25W/m 3500lm/m
- H 30W/m 4500lm/m
- I 40W/m 6000lm/m
- L+ 28W/m 3500lm/m
- M+ 40W/m 5000lm/m

* Altre misure disponibili su richiesta
* More dimensions available

Esempio di codifica: Prodotto KAPPA PLAFONE + Finitura argento + Supporti laterali grigi + Dimensione 900mm + Colore led 4000°K + Potenza 25W/m = Codice: K3.77DBNG
Example of codification: Product KAPPA PLAFONE + Finishing silver + Lateral support grey + Dimension 900mm + Led color 4000°K + Power 25W/m = Code: K3.77DBNG